

## Black Matt | 106.0670.112

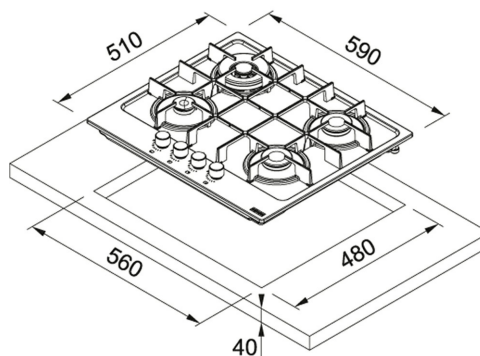





FAMIGLIA : Piani Cottura | FINITURA : Black Matt | PRODUCT LINES : Maris | MODELLO : FHMA 604 3G DC MB C | SERIES : Maris



### DATI TECNICI

Tipo	Piano cottura a gas
Lunghezza totale	590,00 mm
Larghezza totale	510,00 mm
Tipo di controllo	Manopole
Numero Fuochi	4
Potenza (W)	Ausilario - 1000W Doppia corona - 3300W Semi Rapido - 2x1750W
Tecnologia	Gas acciaio o smaltato
Cutout Width	560,00 mm
Profondità Cassetto	480,00 mm
Prezzo	741,00 €

### FUNZIONI

	Griglie in ghisa in dotazione		4 Bruciatori
	Garanzia 2 anni		Larghezza 60 cm Accensione elettronica integrata
	Doppia corona		Valvola di sicurezza