

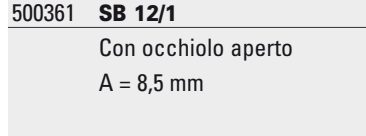

fischer SB 9 - SB 12

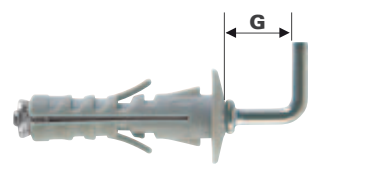
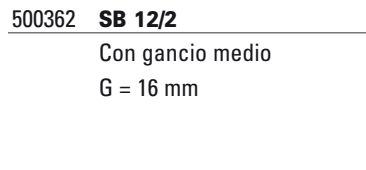

tassello universale in nylon

GARANZIA
NYLON
QUARANTEE

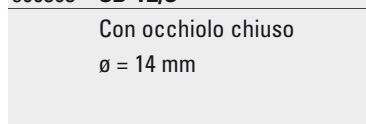
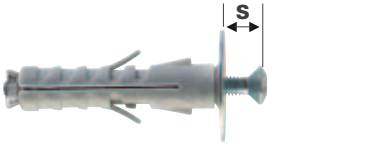
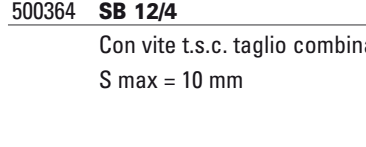
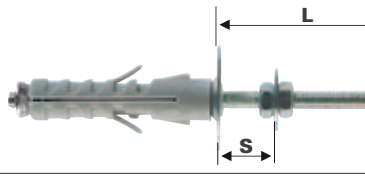
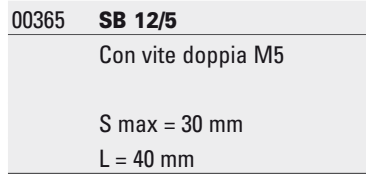
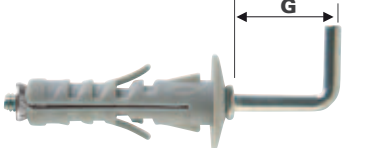
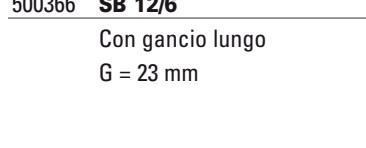
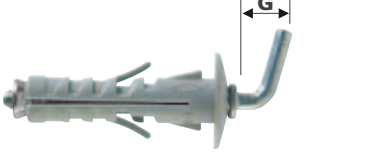
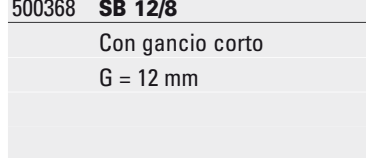
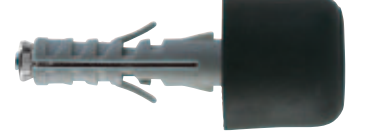
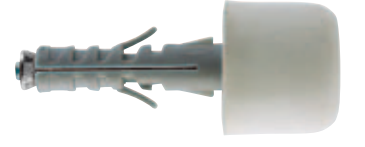
FAMIGLIA PRODOTTI

| art. n. | descrizione | confezione pezzi | art. n. | descrizione | confezione pezzi |
|---|---|------------------|---|--|------------------|
|  | 500341 SB 9/1 Con occhiolo aperto A = 8 mm | 100 |  | 500361 SB 12/1 Con occhiolo aperto A = 8,5 mm | 50 |
|  | 500342 SB 9/2 Con gancio medio G = 14 mm | 100 |  | 500362 SB 12/2 Con gancio medio G = 16 mm | 100 |
|  | 500343 SB 9/3 Con occhiolo chiuso ø = 13 mm | 100 |  | 500363 SB 12/3 Con occhiolo chiuso ø = 14 mm | 50 |
|  | 500344 SB 9/4 Con vite t.s.c. taglio combinato S max = 10 mm | 100 |  | 500364 SB 12/4 Con vite t.s.c. taglio combinato S max = 10 mm | 100 |
|  | 500345 SB 9/5 Con vite doppia M4 S max = 25 mm L = 35 mm | 50 |  | 00365 SB 12/5 Con vite doppia M5 S max = 30 mm L = 40 mm | 50 |
|  | 500346 SB 9/6 Con gancio lungo G = 20 mm | 50 |  | 500366 SB 12/6 Con gancio lungo G = 23 mm | 50 |
|  | 500348 SB 9/8 Con gancio corto G = 10 mm | 100 |  | 500368 SB 12/8 Con gancio corto G = 12 mm | 100 |
|  | 500351 SB 9/11 Con fermaporta in PVC nero | 50 | | | |
|  | 500352 SB 9/12 Con fermaporta in PVC bianco | 50 | | | |

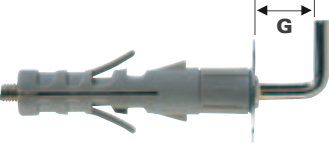
FAMIGLIA PRODOTTI

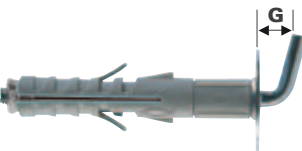
| art. n. | descrizione | confezione pezzi | art. n. | descrizione | confezione pezzi | |
|---|-------------|--|---------|--|---|----|
|  | | | 500370 | SB 12/10 Con gancio piatto regolabile con vite | 25 | |
|  | | | 500372 | SB 12 L 2 Con gancio medio G = 20 mm | 50 | |
|  | | | 500373 | SB 12 L 3 Con occhiolo chiuso ø = 13 mm | 50 | |
|  | 500354 | SB 9 L 4 Con vite t.s.c. taglio combinato S max = 10 mm | 100 | 500374 | SB 12 L 4 Con vite t.s.c. taglio combinato S max = 10 mm | 50 |
|  | 500358 | SB 9 L 8 Con gancio corto G = 12 mm | 100 | 500378 | SB 12 L 8 Con gancio corto G = 15 mm | 50 |

Adatto per

- calcestruzzo
- mattone pieno o forato
- pietra e materiale compatto
- calcestruzzo poroso
- cartongesso

Per fissare

- lampade
- pensili
- specchi
- fili biancheria
- controsoffitti
- pendinature
- scaffalature
- fermaporta
- mensole

DESCRIZIONE PRODOTTO

Generalità

- Tassello universale in nylon disponibile nelle misure: 9 e 12 mm di diametro.
- Vasta gamma di accessori premontati in acciaio.
- L'espansione si ottiene per richiamo del cono filettato avvitando l'accessorio.

Vantaggi

- Il particolare profilo del tassello consente un'efficace espansione.
- Le alette laterali impediscono al tassello di ruotare all'interno del foro.
- Le aperture longitudinali permettono un perfetto adattamento e conseguentemente un'ottima tenuta anche su supporti non compatti.
- L'ampia gamma di accessori lo rende utilizzabile in moltissime applicazioni.

Tipo di installazione

- A filo parete o passante.

Informazioni utili per l'installazione

- Su supporti forati, forare solo a rotazione (senza rotopercolazione).



MONTAGGIO

SB su pieno

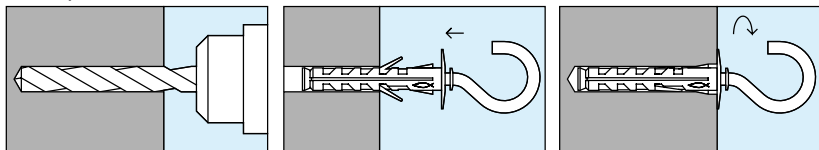

SB su vuoto

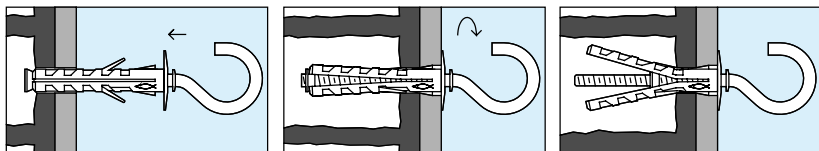

SB 9/4 e SB 12/4

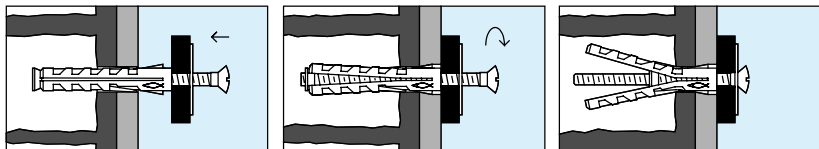

SB 9/5 e SB 12/5

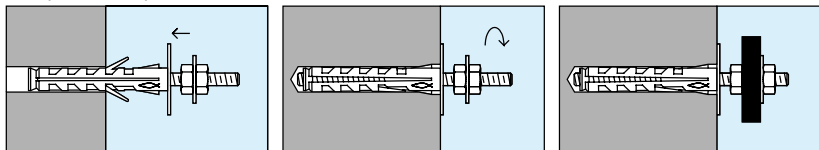

SB 9/11 e SB 9/12

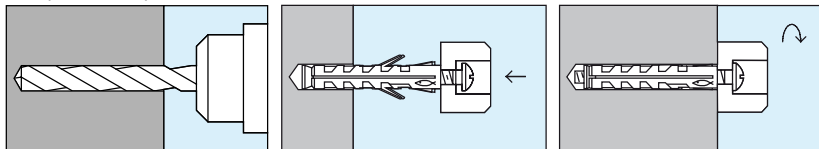

Si raccomanda un'accurata pulizia del foro prima dell'installazione.

DATI TECNICI

| Tassello | Lt | øf | P | øv | ør |
|--------------------|----|----|----|----|----|
| SB 9 | 40 | 9 | 50 | 4 | 22 |
| SB 9 L prolungato | 52 | 9 | 62 | 4 | 22 |
| SB 12 | 45 | 12 | 55 | 5 | 26 |
| SB 12 L prolungato | 57 | 12 | 67 | 5 | 26 |

Valori di estrazione in daN (1 daN ≅ 1 kg)

| Tassello | SB 9/4 | | | | SB 9/8* | | |
|-----------------------------------|---------|---------|---------|----------|---------|---------|-----------|
| | SB 9/1* | SB 9/2* | SB 9/3* | SB 9/4 L | SB 9/5 | SB 9/6* | SB 9/8 L* |
| Calcestruzzo R 250 ⁽¹⁾ | 40* | 40* | 40* | 230 | 230 | 30* | 80* |

* Piegamento accessorio (1) 250 kg/cm²

| Tassello | SB 12/2* | | | SB 12/4 | SB 12/5 | SB 12/8* | |
|-----------------------------------|----------|------------|----------|-----------|-----------|----------|------------|
| | SB 12/1* | SB 12/2 L* | SB 12/3* | SB 12/4 L | SB 12/5 L | SB 12/6* | SB 12/8 L* |
| Calcestruzzo R 250 ⁽¹⁾ | 60* | 80* | 60* | 400 | 400 | 50* | 160* |

* Piegamento accessorio (1) 250 kg/cm²

Si consiglia l'adozione di un adeguato coefficiente di sicurezza secondo i casi (vedi "Guida tecnica").

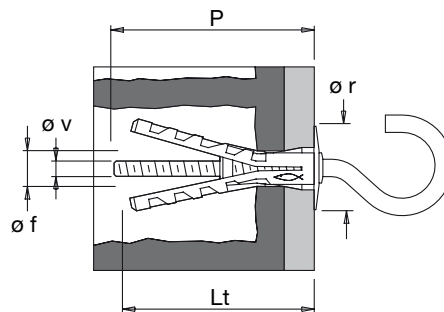

Lt = lunghezza tassello mm
 øf = diametro punta mm
 P = profondità minima foro mm
 øv = diametro vite mm
 ør = diametro rosetta mm