

AY210 Force Feedback Yoke Base



01 Product Features

- MCLS Force Feedback Technology
- 9Nm Roll Force and 200N Pitch Force
- Aluminum Quick Release
- Programmable Switch Panel
- 150mm Long Pitch Travel
- High-Resolution Encoder

02 Parameters

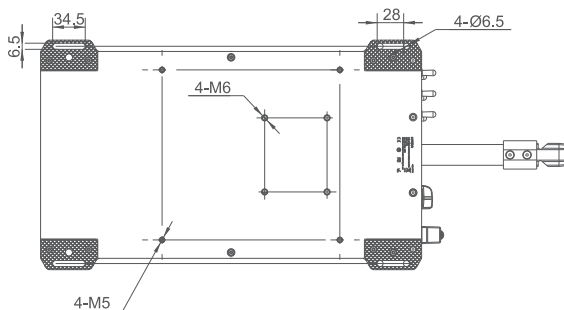
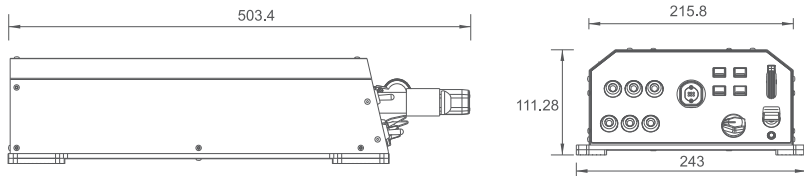

03 Connection Ports

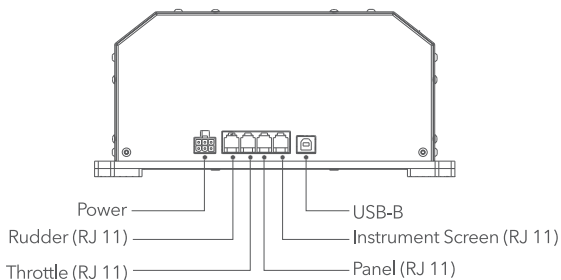

04 User Guide

1. Securing the Yoke

- a. Rotate the D-shaped head of the MOZA Force Feedback Yoke Base to the position shown in the diagram.

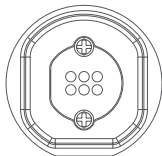

- b. Press and hold the quick release handle on the back of the MFY Yoke Handle then align the yoke with the connecting rod.

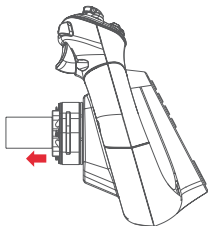

- c. After attaching the yoke, release the quick release handle and gently wiggle the yoke to ensure it is securely mounted.

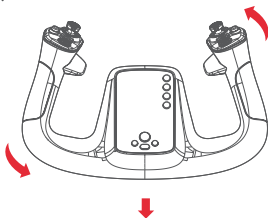

- d. Once connected, power on the MOZA yoke base, and the lights on the MFY yoke handle will illuminate.

* If the connection fails, confirm that the MFY yoke handle is securely attached to the yoke base. If the lights remain off, verify the brightness settings in MOZA Cockpit software.

2. Securing the Yoke Base

Desktop Clamping (Optional Desk Clamp Required):

- Attach the included extension pads to the outer sides of the protruding sections on both sides of the Yoke Base.
- Secure the desk clamp to the protruding sections of the yoke base.
- Tighten the star-shaped handle until the clamp is securely fastened to the desk.

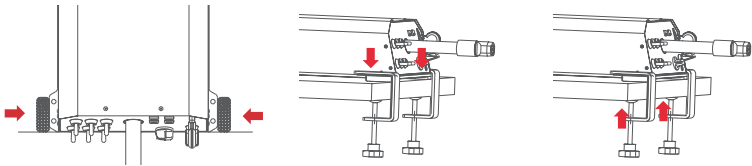

Also, the base can be mounted onto simulator cockpits using the screw holes located on the bottom of the base.

3. Connecting to PC

- Connect the power cable to the MOZA AY210 yoke base and plug it into a 220V outlet. Short press the power button to turn it on (long press to turn it off). The power light will flash upon successful connection.

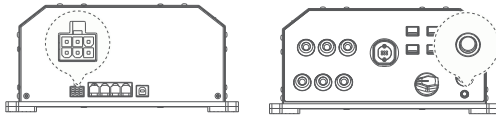

- Use the included USB cable to connect the Type-B end to the corresponding port on the back of the base, and the Type-A end to your PC. If connected successfully, the power light will remain on, and the control panel lights will illuminate.



Download and install the MOZA Cockpit Software from www.mozaracing.com. For additional information and tutorial videos, please visit the official website.

06 Base Features

Cogging Torque Calibration

Click the calibration button on the interface to optimize the cogging feel and balance of the yoke handle. The process may take some time—please wait for the progress bar to complete before proceeding with other operations.

Note: During the calibration process, avoid touching the yoke handle to ensure accurate results.

Base Front Panel Backlight Adjustment

The AY210 base provides two modes for adjusting backlight brightness:

- **Manual Mode:**
Adjust the lighting intensity using the backlight brightness slider in the MOZA Cockpit software.
Brightness levels range from 0 to 15, with level 0 completely turning off the lights.
- **Telemetry Mode:**
Synchronizes the backlight brightness with in-game cockpit lighting using telemetry data.

Landing Gear Light

The landing gear light is located at the top-right corner of the front panel and supports three modes: Off, Red, and Green.

There are two modes for adjusting its brightness:

- **Manual Mode:**
Adjust the lighting intensity using the landing gear light brightness slider in the MOZA Cockpit software.
Brightness levels range from 0 to 15, with level 0 completely turning off the lights.
- **Telemetry Mode:**
Synchronizes the lighting intensity with in-game cockpit lighting using telemetry data.

Landing Gear Status Lighting:

Gear Up Position:

Users can set the landing gear light color for when the gear handle is in the UP position.

Options include:

- **Off:** The landing gear light turns off when the gear is retracted.
- **Red:** The landing gear light illuminates red when the gear is retracted.

Unlocked State:

Users can set the landing gear light color for when the landing gear is in an unlocked state.

Options include:

- **Off:** The landing gear light remains off during the transition.
- **Red:** The landing gear light illuminates red during the transition.

Flap Switch Long-press Timeout

Users can adjust the long-press activation time for the flap switch using the Flap Switch Long-press Timeout slider. This setting determines how long the switch must be held up or down to trigger the long-press function. For example, if set to 2 seconds, holding the flap switch down for 2 seconds will activate the long-press action.

07 Base Force Feedback Settings

Click the base icon in the sidebar to access the force feedback settings. Here, you can adjust the mechanical parameters and fine-tune the force feedback effects, organized into easy-to-navigate tabs. After making adjustments, save your settings as presets using the Preset Management feature for quick access and future use.

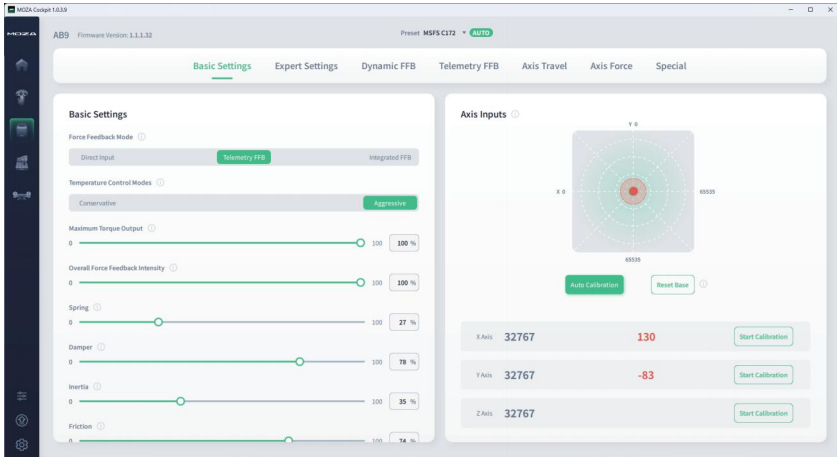

08 Base Reset

If you experience issues with force feedback or axis calibration, try resetting the base by clicking the Reset Base button in the interface.

If the issue persists after resetting, please contact customer support for further assistance. Note that the reset process may take a few moments to complete.

09 Specifications

Supported Platform: PC

Pitch Travel: 150mm

Roll Range: $\pm 90^\circ$

Sustained Roll Torque: 9N·m

Max Pitch Force: 210N

Sensor Resolution: 15-bit

Panel Material: Aluminum alloy

Input Voltage: 110V-220V AC, >36V DC

Current Rating: 6A

Power Consumption: 216W

USB Refresh Rate: 1000Hz

Compatible Yokes: MOZA Yoke Series

Connection Ports: USB Type-B, RJ11

Mounting Options: Desktop clamp (optional);

Suspended desktop clamp (optional); Direct

mounting on a simulator cockpit

Desktop Clamp: Optional

10 Precautions

- Do not expose the device to liquids or humidity as it may cause fire or electric shock.
- Avoid using the device in direct sunlight.
- Do not use MOZA flight sim gear with the MOZA racing gear.
- Recommended indoor temperature: 5°C ~ 35°C.
- For your safety and well-being, please monitor your gaming time and take breaks as needed.
- The device is not suitable for children under the age of 6, small accessories may pose a choking hazard!
- Children under 13 should have adult supervision.
- It is strictly forbidden to disassemble the equipment by yourself, failure to adhere to this will result in loss of warranty.
- The equipment must be connected with the factory-supplied power supply to ensure the electrical safety and the protection of user rights and interests.
- In order to ensure user safety, parts repair or replacement can only be carried out by officially authorized repair centers.
- Non-standard power supplies are strictly prohibited even if data such as related voltages match.
- Use only AC power provided by a standard wall outlet to avoid damage to the product.
- Do not expose the device to heat sources.
- Unplug the power cord of the device if it will not be used for a long time.
- If you find any abnormality, please stop using it immediately and seek help from MOZA representatives or authorized repair centers.
- Stay tuned to our official website and social media platforms for the latest product updates.

Manufacturer: Shenzhen Gudsen Technology Co., Ltd

Address: Room 1903-1904, Building 3, Nanshan
ZhiyuanChongwen Park, No. 3370 Liuxian Avenue,
Nanshan District, Shenzhen China

Web: www.mozaracing.com

E-mail: info@mozaracing.com

Made in China